



Energy Solution Provider

EFOY Pro 12000 Duo

30.09.2015

EFOY Pro 12000 Duo – An SFC Energy fuel cell product



Proven technology



Long autonomy,
maintenance-free



Cluster for even higher power



- ⏻ 500 Watt output power
- ⏻ Automatic 24 or 48 Volts detection
- ⏻ Operating temperatures -20 °C to +40 °C
 - ⏻ Above +40 °C the power output is decreasing
- ⏻ Parallel operation for higher power
- ⏻ Proven EFOY Pro technology

EFOY Pro 12000 Duo – Markets



Markets:

🔌 Applications Off-grid: 100 – 500 W





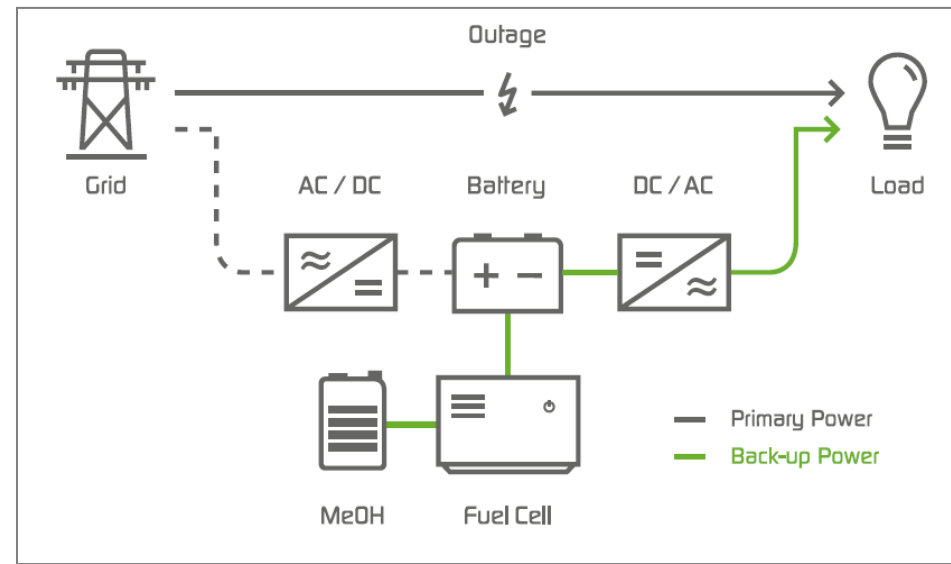

- 🔌 Surveillance
- 🔌 Telecommunication
- 🔌 Traffic Management

🔌 Applications Back-up: 0,5 – 5 kW

- 🔌 Telecommunication
- 🔌 Wind Turbines



EFOY Pro 12000 Duo – Addressable Markets

Markets	10 W	50 W	100 W	500 W	1 kW	5 kW	
Telecommunication 	Repeater Stations Access Points		BTS Base Transceiver Stations Cell-On-Wheels				
Traffic Management 	Traffic Signs	Speed Cameras Road Weather Stations		Toll Collection \ Traffic Counter Construction lightning			
Wind 	Obstacle lights SODAR Measurement		LIDAR Measurement	Back-Up Wind turbine			
Security & Surveillance 	Video surveillance CCTV		Mobile surveillance		TETRA funk Authority surveillance		
Oil & Gas 	Pipeline sensors		Injection pump Air compressors		Injection pump, Air compressors Constant torque applications		
Environmental data 	Hydro-/Geological Measurement Avalanche detection		Weather Station				
	EFOY Pro 800 / 2400		EFOY Pro 800 / 2400		500 W DMFC	500 W DMFC	500 W DMFC

EFOY Pro 12000 Duo – Product features

EFOY Pro 12000 Duo	
Max. nominal power	500 W
Min. nominal power	400 W
Nominal Current @ 24 V / 48 V	20,8 A / 10,4 A
Weight	32 kg / 70.4 lbs
Warranty	24 Month / 3.000 hours
Operating Temperature	-20 to +50 °C (-4 to +122 °F)
Fuel Consumption	0.9 l/kWh
Dimensions (l x w x h)	640 x 441 x 310 mm (25.2 x 17.3 x 12.2 in)



Start serial production planned for end of 2015

EFOY Pro 12000 Duo – Product features

	EFOY Pro 12000 Duo
Operating temperature*	-20 °C to +50 °C / -4 °F to +122 °F
Start-up temperature	+3 °C to +50 °C / +37.4 °F to +122 °F
Storing temperature	+1 °C to +50 °C / +34 °F to +122 °F

* Power output reduction over +40 °C / +104 °F

EFOY Pro 12000 Duo – Product features

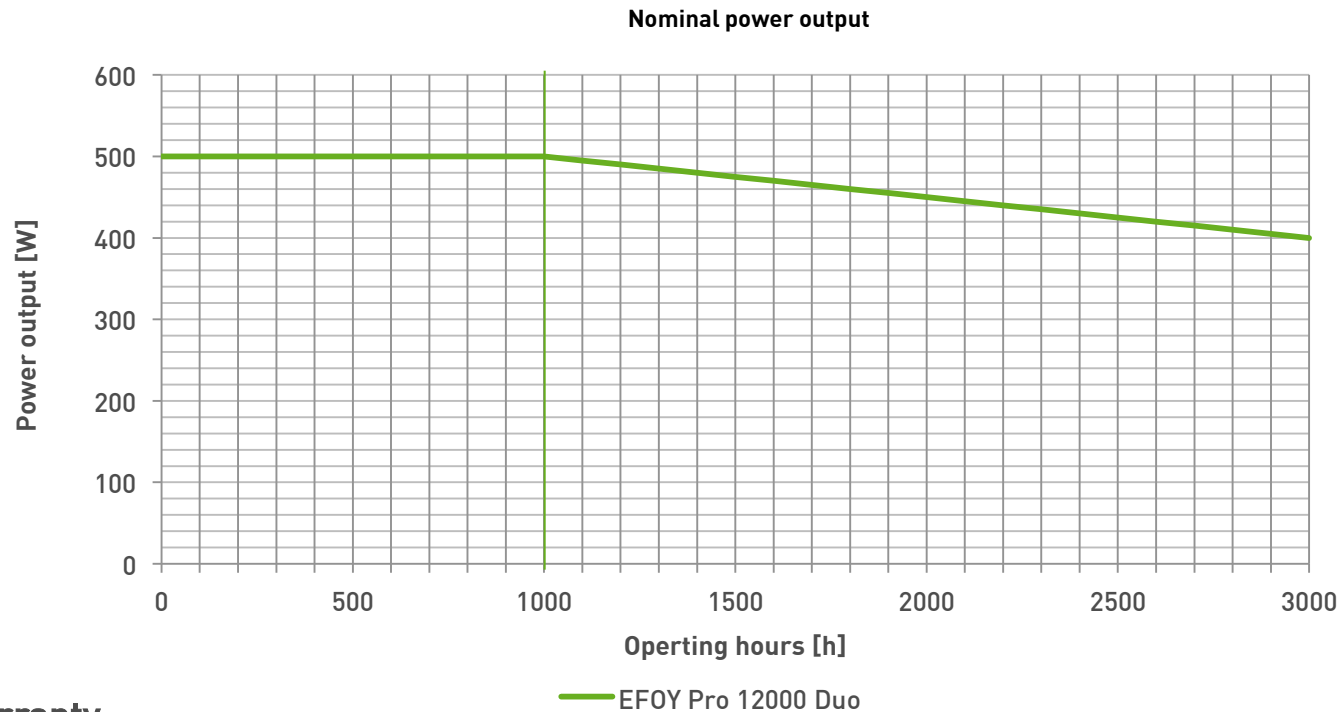

End of warranty

- ⏻ No Degradation in the first 1.000 operation hours
- ⏻ The output power will decrease after 1.000 operation hours with 50 mW/hour (5 W /100 hours)
- ⏻ Reduction of output power is linear and it is the minimum output power
- ⏻ EFOY Pro still works after 3.000 operation hours, it just takes longer to charge the batteries

EFOY Pro Fuel Cells: Function Diagram

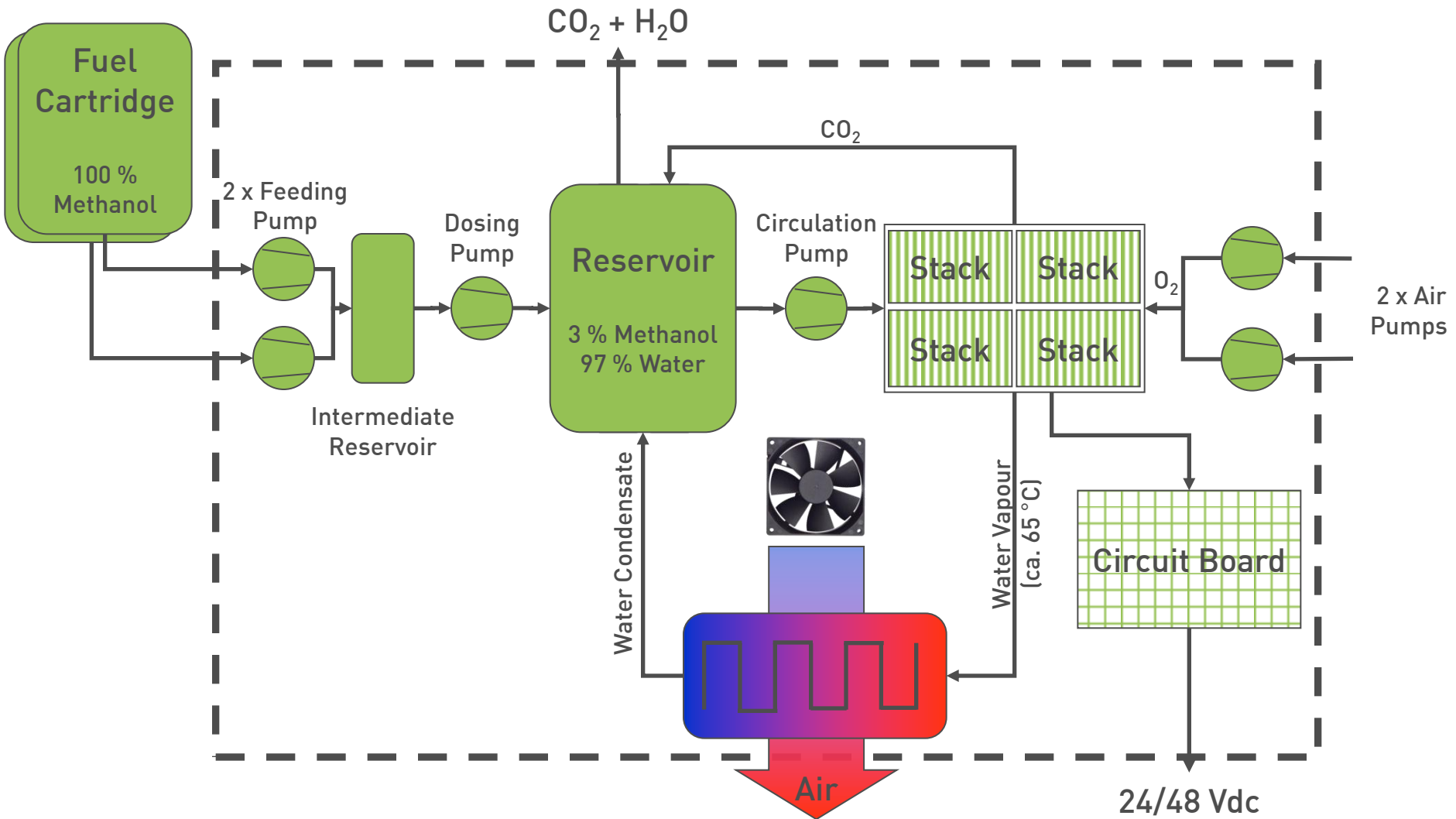

EFOY Pro 12000 Duo - Design Prototypes

Front:

- ⏻ Operation panel for on site control
- ⏻ RJ 45 Slots (Remote Control, Data Interface)
- ⏻ 2 x fuel cartridge connectors

Back:

- ⏻ Communication connections (RS232 / Modbus)
- ⏻ Electrical connection (Power and Sense)
- ⏻ Exhaust hose connection

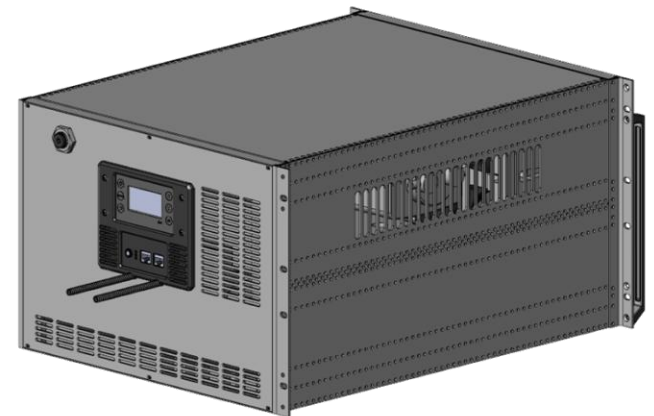

EFOY Pro 12000 Duo - Design Prototypes

Fuel connectors

Warm air

Air intake

Service fluid valve

Heat exchanger

drainage valve

Communication

Electrical connection

Exhaust hose opening

EFOY Pro 12000 Duo – Scope of delivery

Teilenummer	Bezeichnung	Anzahl
500 903 001	Initial Start Fluid 1,5l	1
500 903 002	Recovery fluid 0,5l	2
500 901 001	User Manual EFOY Pro 12000 Duo	1
500 904 001	Isolated exhaust hose 1 m	1

Initial Start Fluid 1,5l:

Necessary for first startup. The fuel cell is shipped empty, the „Initial Start Fluid“ it is filled up with a water methanol mixture.

Recovery Fluid 0,5l:

The “Service Fluid” for the EFOY Pro 12000 Duo, only to be filled when display shows message.



Toxicity of fluid is below limits, therefore no hazardous goods!

Installation: Battery Recommendations

Battery Voltage	EFOY Pro 800 / 800 Duo	EFOY Pro 2400 / 2400 Duo	EFOY Pro 12000 Duo
12 V	60 – 200 Ah	120 - 400 Ah	X
24 V	30 – 100 Ah	60 - 200 Ah	100 Ah - 800 Ah
48 V	X	X	50 Ah – 400 Ah

Recommended battery type 12 V batteries (lead-acid, lead-gel, AGM or LiFePO4)

Recommended battery capacity depends on battery type and application - bigger batteries possible, if charging current sufficient (e.g. solar batteries)

In general:

- 🔌 Do not go below stated minimal capacities
- 🔌 Few long charging cycles are better than many short ones; consumption and abrasion are higher in starting phases
- 🔌 If running times of less than one hour are common, lower the switching on threshold or use a bigger battery

EFOY Pro 12000 Duo – Installation requirements

- 🔌 Installation space (incl. air duct)
LxWxH: 1000 x 482.6 x 355.6 mm.
- 🔌 Distance should be the same between air supply and off-heat.
- 🔌 Supply air and exhaust opening (1):
min. 600 cm²
- 🔌 Ventilation gills and fly-screen are necessary.
- 🔌 Separation of air supply (2) and off heat (3) is necessary (4).
- 🔌 The electrical connections, the fill port for service fluid and the fuel cartridge should be easily accessible.
- 🔌 The unit should be fixed in the installation space.

